

VFB Plus

VFB Plus Ventilated Fire Barrier

Tenmat's VFB Plus Ventilated Fire Barriers are "open state" cavity fire barriers designed to offer fire resistance performance within external wall cavities that require permanent (open-state) ventilation in non-fire conditions.

Product Description

Tenmat's VFB Plus Ventilated Fire Barriers are 'open state' cavity fire barriers for ventilated cavities of up to 450mm.

Each VFB Plus consists of a specially formulated fire rated stone mineral wool section with an integral high expansion intumescent seal fixed to the leading edge.

The VFB Plus then leaves a maximum 44mm air gap to allow for drainage and maintain ventilation in normal use.

In a fire situation the intumescent seal rapidly expands to seal off the air gap and prevent vertical fire spread within the external wall.

The product has undergone extensive fire testing following the principles of BS EN1363-1 and in accordance with ASFP TGD19 (Fire Resistance Test for 'Open-State' Cavity Barriers).

The VFB Plus are mechanically fixed horizontally within ventilated cavities behind the external wall substrate following the fire compartment line.

The VFB Plus are used horizontally and can be installed in conjunction with Tenmat NVFB Non-Ventilated Fire Barriers which provide vertical fire separation along fire compartment party wall lines.

Product Details

- CCPI Verified
- 3rd Party Certification - IFC Certification
- Typical Fire Ratings of minimum 30 to 60 minutes Integrity and Insulation
- Higher Fire Ratings available dependent on application
- Fire Tested on Timber Frame Systems
- Fire Tested on Steel Frame Systems (SFS)
- Maintains a 44mm air gap
- Up to 450mm cavities tested
- Standard thickness of 75mm
- Durability and Age Tested
- Fixing brackets included as standard

Sizes

Thickness (Total Cavity less 44mm Air Gap) x 75mm x 1000mm

Fire Test Evidence

Fire Test performance to BS EN 1363-1 and to the principles of ASFP TGD19

Inner Leaf Substrate Type (facing cavity) with Appropriate minutes Fire Resistance	Outer leaf Substrate Type (facing cavity) With Appropriate Fire Resistance	Orientation	Insulation Type Within Cavity (interrupted)	Maximum Cavity Width (in mm)	Maximum Open State Air Gap (In mm)	Product Dimensions (thickness x height x length in mm)	Product Fire Resistance Rating	
							Integrity	Insulation
10mm Cement Particle Board (Cempanel)	Autoclaved Aerated Concrete	Horizontal	None	60	44	16 x 75 x 1000	180	180
12.5mm Weather Defence Board on SFS	Autoclaved Aerated Concrete	Horizontal	25mm Phenolic	80	44	36 x 75 x 1000	120	90
Autoclaved Aerated Concrete	Autoclaved Aerated Concrete	Horizontal	100mm PIR	300	44	256 x 75 x 1000	60	60
Autoclaved Aerated Concrete	Autoclaved Aerated Concrete	Horizontal	100mm PIR	450	44	406 x 75 x 1000	30	30
12.5mm Weather Defence Board (Siniat Gtec)	Autoclaved Aerated Concrete	Horizontal	100mm PIR	450	44	406 x 75 x 1000	30	30
12.5mm Calcium Silicate Board (Y Wall)	Autoclaved Aerated Concrete	Horizontal	100mm PIR	450	44	406 x 75 x 1000	60	30
Timber Frame ¹	Autoclaved Aerated Concrete	Horizontal	None	60	44	16 x 75 x 1000	120	90
Timber Frame ¹	Autoclaved Aerated Concrete	Horizontal	None	300	44	256 x 75 x 1000	30	30

3rd Party Certification:

IFC Certification - Certificate No. IFCC 1750

Fire Test Evidence:

Field of Application Report - PAR22672/01

¹ Timber Frame inner substrate tested with min. 9mm thick OSB Sheathing Board with a minimum 35mm thick timber stud that must be in place directly behind the sheathing board in line with the cavity barrier.

The fire rating required on Timber Frame projects would typically be expected to be 30 minutes only. The fire ratings and information provided in this document and supporting fire test evidence is not intended to be a complete specification for the proposed cavity barrier and it is the responsibility of others (the Principal Designer) to ensure that the product/assembly is suitable for the intended purpose.

The types of insulation tested do not infer generic approval for these insulation products and approval should be sought from the insulation manufacturers depending upon the particular type of construction being built. Insulation is tested interrupted to prevent the possibility of fire bypassing behind the cavity barrier.

The ASFP-TGD19 test standard allows for insulation to be replaced with insulation that is listed as better using the hierarchy as below and must be installed interrupted. Notes on insulation from TGD19:2017-13.3 Insulation. For interrupted insulation the following hierarchy is used:

Best- stone wool, glass wool, phenolic, PIR, PUR, EPS - Worst

Fire test evidence, safety data sheets and previous versions of product information are all available upon request by contacting Tenmat, please [click here](#)

Technical Information

Colour	Red
Finish	Polythene Wrap
Storage	Dry, ambient (see Safety Data Sheet)
Weight	Bespoke sizes ranging from 0.4kg to 4kg dependent on size to suit cavity width.
Thermal Conductivity - EN 13162	$\lambda_b = 0.035 \text{ W/mK}$
Reaction to Fire	The stone wool element is Classified 'A1' to EN 13501-1. The intumescent/reactive seal on the leading edge is Class 'E' to EN 13501-1. This is permitted where intumescent and fire stopping materials are necessary to meet the requirements of Approved Document B as per Building Regulations section 7(3)(f).
Fire Resistance	See Fire Test Evidence table.
Durability to EOTA TRO24 (Intumescent/Reactive Seal)	Type X - intended for outdoor use or exposed to free weathering - rain, UV, high temperatures in summer, frost and frost-thaw in winter. ¹
Durability of reaction to fire and thermal conductivity to EN 13162 (stone wool element)	Reaction to fire and thermal conductivity does not change with time against heat, weathering, ageing/degradation.
European Product Declaration (EPD)	EPD in accordance with EN15804+A2 & ISO 14025 / ISO 21930 ²
Smoke Generation - BS EN 45545-2	Low Smoke Generation in intumescent material testing ³ Tenmat FF102 Results Ave. Ds(max)20 value =3 Max. limit 300 as per EN45545-2
Halogen Content	Halogen-free Tested Max. Values Fluorine = 0.0006% / 6ppm Bromine = 0.0001% / 1ppm Chlorine = 0.0007% / 7ppm Iodine = 0.0006% / 6ppm Max. limit 0.5% / 5000ppm ⁴
Working Life	60 years ⁵
Dimensional Tolerances	Thickness +10/-0mm Width +5/-0mm Length +0/-5mm

The product is not subject to any warning or ban under Section 26 of the NZ Building Act 2004.

Working life, smoke generation and halogen content data refers to the active intumescent component.

¹ Type X testing to EOTA TRO24 detailed in Report - (2300/522/18) - 2/2018 - Br/Mü dd. 2018/06/06.

² European Product Declaration (EPD) - Report HUB-2489.

³ Testing for Ds(max)20 records the greatest smoke density generated during twenty minutes, it is a logarithmic expression relating to how much light can be transmitted through the smoke. In the EN45545-2 standard, a maximum value of 300 must be demonstrated for the most demanding applications, typically underground passenger rail with autonomous vehicles. Tenmat's intumescent material can therefore be considered to be low-smoke. Test evidence in Doc. Ref. 396264.

⁴ According to the IEC 60754-1 standard, halogen-free equates to less than 0.5% / 5000ppm hydrogen halide gas release on combustion. This means materials must contain below these levels for fluorine, chlorine, bromine, or iodine. Doc. Ref. 3802815

⁵ Independent 3rd party review of test data confirmed the intumescent would be expected to be capable of performing its function for a period of at least 60 years in an environment which is protected from the elements for normal temperature range of -5C to +30C but can reasonably be expected to cope with intermittent extremes in the range of -20C to +50C. KIWA Technical Report TN/25082/01.

General Design & Installation Considerations

Maximum free air gap for this cavity barrier is 44mm, the space in front of the intumescent strip on the face of the cavity barrier to the rear of the external wall surface.

Open state cavity barriers should be installed in a continuous run, (with the exception of abutting up to full fill vertical cavity barriers). Where this is not possible, details should be agreed with the project's principal designer and or fire engineer.

Horizontal cavity barriers should be installed adjacent and tightly abutted to any vertical cavity barriers, the vertical cavity barriers should be installed first.

Cavity barriers may be cut to length as required, adjacent lengths must be tightly abutted together.

The intumescent face of the cavity barrier should be unrestricted and free to expand in a fire situation, fully filling the cavity.

An identification label is attached to the intumescent face of the cavity barrier, ensure this faces out into the open cavity. Also ensure the label is visible and legible and reads the right way up.

If the identification label is not legible please contact Tenmat, the label is important in terms of identifying the product in the future, for example during fire risk assessments or fire safety inspections.

Cavity barrier fixing brackets, both multi purpose, (MP bracket) or high performance (HP bracket) must not penetrate through the face of the cavity barrier.

Screws for direct fixing and fixings to secure brackets are not supplied by Tenmat.

The brackets used to fix the horizontal cavity barrier must be installed with the spike inserted centrally (horizontally) to the rock mineral wool section of the cavity barrier with the bracket fixed above and not below the cavity barrier.

For Timber Frame constructions, a minimum 35mm thick timber stud must be in place directly behind the sheathing board following the line with the cavity barrier.

The use of tape is not required over the joints between the lengths of cavity barrier.

The cavity barrier must be installed following the installation methods described below.

The cavity barrier must not be penetrated by any other mechanical or electrical services.

Fitting Instructions VFB Plus

Fire Barrier Support Details

Cavity Size (mm)	Product Width (mm)	Fitting Option Number	Barrier Support Type	No. of supports per metre	Maximum Centres (mm)
60-120	16-76	1	Screw	4	250
121-134	77-90	2	MP Bracket	2	500
135-259	91-215	3	MP Bracket	2	500
260-300	216-256	4	MP Bracket	3	350
301-450	257-406	5	HP Bracket	2	500

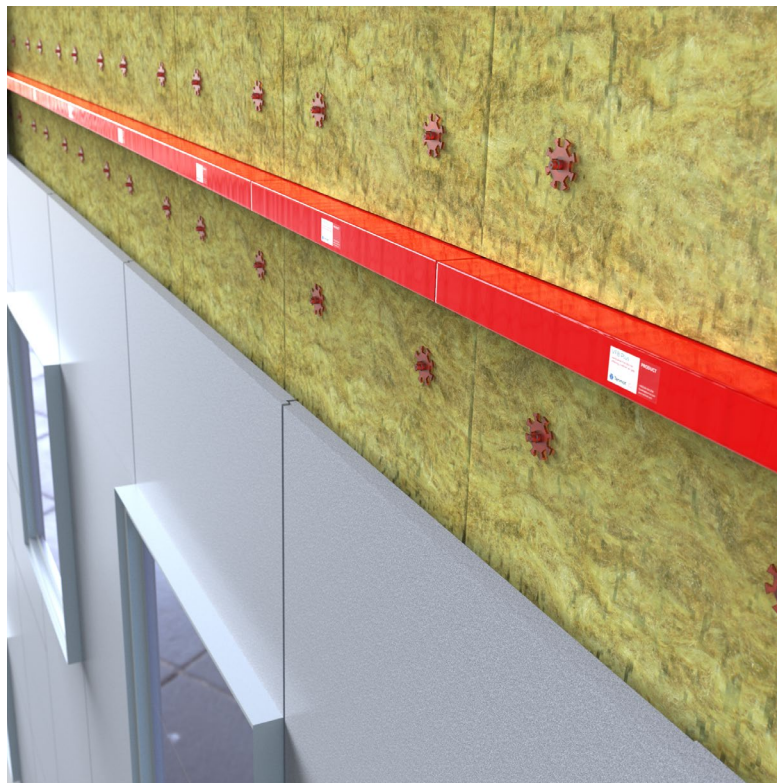

Option 1

VFB Plus- Product width across cavity 16mm up to 75mm wide, directly faced fixed

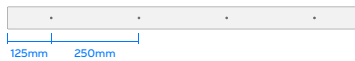
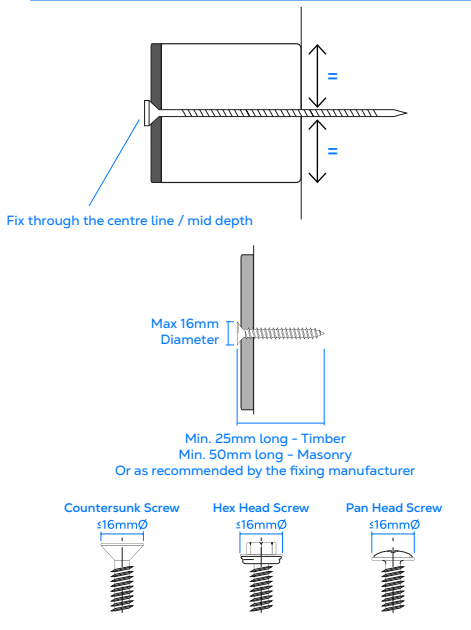

Use stainless steel screws, with a maximum head diameter of 16mm and with a length suitable for the size of cavity barrier and embedment into the substrate.

Fixings must have an appropriate fixing depth for the substrate (with a minimum of 50mm for masonry fixings and minimum 25mm for timber unless otherwise specified by the fixing manufacturers guidance for their fixing type).

Ensure that the screw head does not fully penetrate the face of the cavity barrier, the screw head should sit flush or slightly proud on the intumescent front face.

Care should be taken not to over tighten as this may affect the performance of the intumescent seal.

For full metre lengths, position the first screw fixing through the centre line / mid depth of the face of the cavity barrier at a maximum 125mm from one end, continue to face fix through at maximum 250mm centres (4 screws per linear meter), ensuring that the final fixing is a maximum 125mm from the end of the cavity barrier. This will ensure that face fixings are positioned at 250mm centres across the continuous run of cavity barrier.

Where sections of cavity barrier are less than 1 linear meter in length, ensure that face fixings are positioned at a maximum 125mm from each end with additional fixing being positioned at maximum 250mm centres between the end fixings.

For installations in Timber Frame constructions, a minimum 35mm thick timber stud must be in place directly behind the sheathing board following the line with the cavity barrier.

Cut Sections

For sections 200mm or less, each section must have minimum one face fixing in place, positioned centrally. It is recommended to use two fixings for cut sections of 200mm or less.

Sections 200 to 500mm must have minimum 2No. fixings in place, 500 to 750mm is 3No. and 750 to 1000mm is 4No. fixings and they must be equally spaced with not more than 250mm between fixings and not more than 125mm for either end.

Slitting

If the intumescent strip on the front face of the cavity barrier is slit to allow fitting around vertical rails, it must be ensured that every slit section of cavity barrier has fixings in place.

Vertical slits must kept as small as practicable, ensuring no gaps remain and the depth of slit is to minimum the depth of the rail and maximum 10mm deeper than the rail.

Additional face fixings at maximum 125mm to either side of each cut, and ensure that the fixings are no more than 250mm centres from the additional fixings applied.

Suitable fixings remain as per above specification.

Option 2

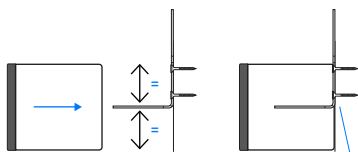
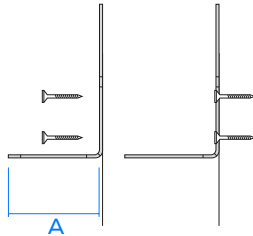
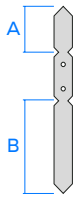

Fix through the mid barrier depth

VFB Plus- Product width across cavity from 76mm up to 90mm, fixed using 2x MP Brackets (with 65mm leg).

MP brackets are supplied with 2 fixing spikes, one spike is 65mm long (A), the other is 160mm long (B), with a central pre drilled section for securing the bracket to the substrate.

For cavity barriers 76mm-90mm wide (across cavity) use 2 MP brackets and the 65mm (A) long spike.

To secure the bracket use nom. 5mm diameter stainless steel screws/fixings of a length and type suitable for the substrate.

Fix through both of the fixing holes.

Fixings must have an appropriate fixing depth for the substrate (with a minimum of 50mm for masonry and minimum 25mm for timber unless otherwise specified by the fixing manufacturers guidance for their fixing type).

Fix 2 number MP brackets, per linear meter, to the substrate at maximum 250mm from the end of the cavity barrier, with a maximum spacing between brackets of 500mm.

Where sections of cavity barrier are less than 1 linear meter in length, ensure that MP brackets are positioned at a maximum 250mm from each end. For cut sections of cavity barrier less than or equal to 200mm in length only one MP bracket is required.

Push the cavity barrier onto the bracket spike, the brackets should impale the VFB Plus to approximately mid barrier depth and must not protrude through the intumescent element.

The cavity barrier should be pushed fully onto the bracket spike and sit flush with the substrate, at the rear of the cavity barrier.

For Timber Frame constructions, a minimum 35mm thick timber stud must be in place directly behind the sheathing board following the line with the cavity barrier.

Cut Sections

Each metre length of cavity barrier is supplied with 4No. face fixings pre-installed underneath the polythene outer to hold the intumescent strip in place.

It must be ensured that if the cavity barriers are cut to length that sufficient face fixings are in place to hold the intumescent strip to the stonewool backing.

It is not allowable to have any cut sections without a face fixing in place.

For sections 200mm or less, each section must have minimum one face fixing in place, positioned centrally. It is recommended to use two fixings for cut sections of 200mm or less.

Sections 200 to 500mm must have minimum 2No. fixings in place, 500 to 750mm is 3No. and 750 to 1000mm is 4No. fixings and they must be equally spaced with not more than 250mm between fixings and not more than 125mm for either end.

Slitting

If the intumescent face on the front face of the cavity barrier is slit to allow fitting around vertical rails, it must be ensured that every slit section of cavity barrier has face fixings through the face of the intumescent material.

Vertical slits must kept as small as practicable, ensuring no gaps remain and the depth of slit is to minimum the depth of the rail and maximum 10mm deeper than the rail.

Additional face fixings at maximum 125mm to either side of each cut, and ensure that the factory fitted face fixings are no more than 250mm centres from the additional fixing applied.

Suitable face fixings for cut or slit sections are 65mm long stainless steel pig tail screws.

Option 3

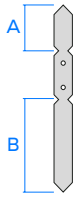

VFB Plus – Product width across cavity from 91mm up to 215mm fixed using 2 multi purpose (MP) 160mm brackets.

MP brackets are supplied with 2 fixing spikes, one spike is 65mm long (A), the other is 160mm long (B), with a central section for securing the bracket to the substrate.

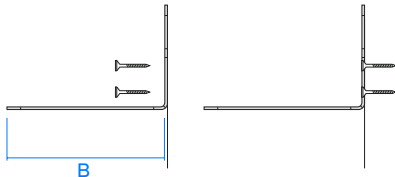

For cavity barriers 91mm-215mm wide (across cavity) use 2 MP brackets and the 160mm (B) long spike.

The 160mm spike will require cutting to size to ensure that the spike does not pierce through the face of the intumescent material.

The bracket should be cut to provide a minimum projection through the barrier to 3/4 of the cavity barrier width and to a minimum of 10mm behind the face of the intumescent strip.

To secure the bracket use nom. 5mm diameter stainless steel screws/fixings of a length and type suitable for the substrate.

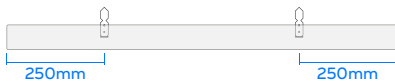

Fix through both of the fixing holes.

Fixings must have an appropriate fixing depth for the substrate (with a minimum of 50mm for masonry and minimum 25mm for timber unless otherwise specified by the fixing manufacturers guidance for their fixing type).

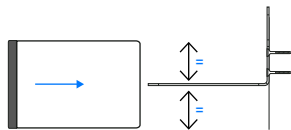

Fix 2 number MP brackets, per linear meter, to the substrate at maximum 250mm from the end of the cavity barrier, with a maximum spacing between brackets of 500mm. Where sections of cavity barrier are less than 1 linear meter in length, ensure that MP brackets are positioned at a maximum 250mm from each end. Where the cavity barrier is less than or equal to 200mm in length 1 MP bracket may be used.

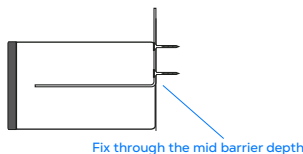

Push the cavity barrier onto the bracket spike, the brackets should impale the VFB to mid barrier depth and must not protrude through the intumescent element.

The cavity barrier should be pushed fully onto the bracket spike and sit flush with the substrate at the rear of the cavity barrier, ensuring that there are no gaps behind the cavity barrier.

For installations in Timber Frame constructions, a minimum 35mm thick timber stud must be in place directly behind the sheathing board following the line with the cavity barrier.

Cut Sections

Each metre length of cavity barrier is supplied with 4No. face fixings pre-installed underneath the polythene outer to hold the intumescent strip in place.

It must be ensured that if the cavity barriers are cut to length that sufficient face fixings are in place to hold the intumescent strip to the stonewool backing.

It is not allowable to have any cut sections without a face fixing in place.

For sections 200mm or less, each section must have minimum one face fixing in place, positioned centrally. It is recommended to use two fixings for cut sections of 200mm or less.

Sections 200 to 500mm must have minimum 2No. fixings in place, 500 to 750mm is 3No. and 750 to 1000mm is 4No. fixings and they must be equally spaced with not more than 250mm between fixings and not more than 125mm for either end.

Slitting

If the intumescent face on the front face of the cavity barrier is slit to allow fitting around vertical rails, it must be ensured that every slit section of cavity barrier has face fixings through the face of the intumescent material.

Vertical slits must kept as small as practicable, ensuring no gaps remain and the depth of slit is to minimum the depth of the rail and maximum 10mm deeper than the rail.

Additional face fixings at maximum 125mm to either side of each cut, and ensure that the factory fitted face fixings are no more than 250mm centres from the additional fixing applied.

Suitable face fixings for cut or slit sections are 65mm long stainless steel pig tail screws.

Option 4

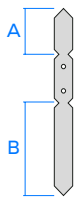

VFB Plus -Product width across cavity from 216mm up to 256mm fixed using 3 multi purpose (MP) 160mm brackets.

MP brackets are supplied with 2 fixing spikes, one spike is 65mm long, the other is 160mm long, with a central section for securing the bracket to the substrate.

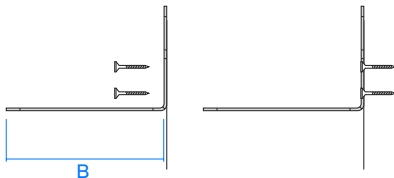

For cavity barriers 216mm–256mm wide (across cavity) use 3 MP brackets and the 160mm (B) long spike. To secure the bracket use nom. 5mm Ø stainless steel screws/fixings, with a maximum head diameter of 13mm and with a length and type suitable for the substrate.

Ensure that the screw head sits as flush as possible with the substrate.

Fix through both of the fixing holes.

Fixings must have an appropriate fixing depth for the substrate (with a minimum of 50mm for masonry and minimum 25mm for timber unless otherwise specified by the fixing manufacturers guidance for their fixing type).

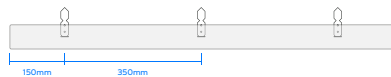

Fix 3 number MP brackets, per linear meter, to the substrate at maximum 150mm from the end of the cavity barrier, with a maximum spacing between brackets of 350mm.

Where sections of cavity barrier are less than 1 linear meter in length, ensure that MP brackets are positioned at a maximum 150mm from each end.

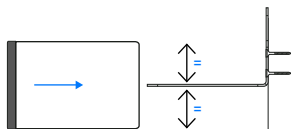

Where the cavity barrier is less than or equal to 350mm in length 1 MP bracket may be used.

Push the cavity barrier onto the bracket spike, the brackets should impale the VFB to approximately mid barrier depth and must not protrude through the intumescent element.

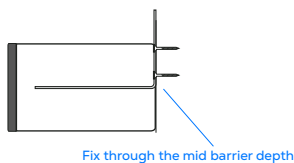

The cavity barrier should be pushed fully onto the bracket spike and sit flush with the substrate, at the rear of the cavity barrier, ensuring that there are no gaps behind the cavity barrier.

For installations in Timber Frame constructions, a minimum 35mm thick timber stud must be in place directly behind the sheathing board following the line with the cavity barrier.

Cut Sections

Each metre length of cavity barrier is supplied with 4No. face fixings pre-installed underneath the polythene outer to hold the intumescent strip in place.

It must be ensured that if the cavity barriers are cut to length that sufficient face fixings are in place to hold the intumescent strip to the stonewool backing.

It is not allowable to have any cut sections without a face fixing in place.

For sections 200mm or less, each section must have minimum one face fixing in place, positioned centrally.

Sections 200 to 500mm must have minimum 2No. fixings in place, 500 to 750mm is 3No. and 750 to 1000mm is 4No. fixings and they must be equally spaced with not more than 250mm between fixings and not more than 125mm for either end.

Slitting

If the intumescent face on the front face of the cavity barrier is slit to allow fitting around vertical rails, it must be ensured that every slit section of cavity barrier has face fixings through the face of the intumescent material.

Vertical slits must kept as small as practicable, ensuring no gaps remain and the depth of slit is to minimum the depth of the rail and maximum 10mm deeper than the rail.

Additional face fixings at maximum 125mm to either side of each cut, and ensure that the factory fitted face fixings are no more than 250mm centres from the additional fixing applied.

Suitable face fixings for cut or slit sections, are 65mm long stainless steel pig tail screws.

Option 5

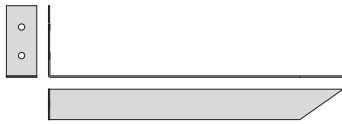

VFB Plus-Product width across cavity from 257mm-406mm wide (across cavity) fixed using 2 high performance (HP) 328mm brackets.

HP brackets are supplied with a single fixing spike, at 328mm long with 6mm \varnothing pre drilled fixing holes and a 90° return angle for securing the bracket to the substrate.

The 328mm spike will require cutting to size, if used in barriers less than 350mm wide, to ensure that the spike does not pierce through the face of the intumescent material.

The bracket should be cut to provide a minimum projection through the barrier to 3/4 of the cavity barrier width and to a minimum of 10mm behind the face of the intumescent strip.



To secure the bracket use nom. 5mm diameter stainless steel screws/fixings of a length and type suitable for the substrate.

Fix through both of the fixing holes.

Fixings must have an appropriate fixing depth for the substrate (with a minimum of 50mm for masonry and minimum 25mm for timber unless otherwise specified by the fixing manufacturers guidance for their fixing type).

Fix 2 number HP brackets, per linear meter, to the substrate at maximum 250mm from the end of the cavity barrier, with a maximum spacing between brackets of 500mm.



Where sections of cavity barrier are less than 1 linear meter in length, ensure that MP brackets are positioned at a maximum 250mm from each end. Where the cavity barrier is less than 200mm in length 1 HP bracket may be used.

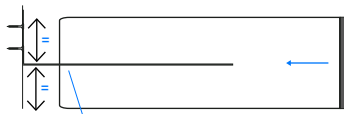

Fix through the mid barrier depth

Push the cavity barrier onto the bracket spike, the brackets should impale the VFB Plus to approximately mid barrier depth and must not protrude through the intumescent element. The cavity barrier should be pushed fully onto the bracket spike and sit flush with the substrate, at the rear of the cavity barrier.

Cut Sections

Each metre length of cavity barrier is supplied with 4No. face fixings pre-installed underneath the polythene outer to hold the intumescent strip in place.

It must be ensured that if the cavity barriers are cut to length that sufficient face fixings are in place to hold the intumescent strip to the stonewool backing.

It is not allowable to have any cut sections without a face fixing in place.

For sections 200mm or less, each section must have minimum one face fixing in place, positioned centrally. It is recommended to use two fixings for cut sections of 200mm or less.

Sections 200 to 500mm must have minimum 2No. fixings in place, 500 to 750mm is 3No. and 750 to 1000mm is 4No. fixings and they must be equally spaced with not more than 250mm between fixings and not more than 125mm for either end.

Slitting

If the intumescent face on the front face of the cavity barrier is slit to allow fitting around vertical rails, it must be ensured that every slit section of cavity barrier has face fixings through the face of the intumescent material.

Vertical slits must kept as small as practicable, ensuring no gaps remain and the depth of slit is to minimum the depth of the rail and maximum 10mm deeper than the rail.

Additional face fixings at maximum 125mm to either side of each cut, and ensure that the factory fitted face fixings are no more than 250mm centres from the additional fixing applied.

Suitable face fixings for cut or slit sections are 65mm long stainless steel pig tail screws.

Limitations

To ensure compliance to the relevant test evidence detailed within this Data Sheet, the product must be installed as per the fitting instructions by competent installers. The product must only be used in a horizontal orientation.

Maintenance

- No active maintenance required.
- Where alterations are made around the product it should be checked visually to ensure that the product is still installed as per the approved original design and fitting instructions at the time of original installation.
- Where product(s) is damaged or tampered, new product should be installed in line with installation guidance.

Storage Conditions

- See Safety Data Sheet

Tools Required

- Sharp Knife
- Measuring Tape
- Appropriate drill
- Stainless steel fixings

PPE Required

- Hand protection
- Eye protection
- Follow project site requirements

Disposal

- Outer packaging can be cleaned and recycled.
- Intumescent and stone wool insulation is non hazardous waste and is categorised as “waste accepted at landfill for non-hazardous waste” and local regulations should be followed.

Please see Safety Data Sheet for more information.

VFB Plus

Tenmat Ltd.
Northbanks Industrial Park,
Irlam, Frank Perkins Way,
Greater Manchester,
M44 5EW

+44 161 872 2181
fpsales@tenmat.com

tenmat.com



Advanced materials.
tenmat.com

Tenmat warrants the materials it produces will conform to Tenmat specifications and approved drawings where applicable. It is entirely the customer's responsibility to make the final product choice and satisfy themselves of the suitability of the product for the intended application, carrying out testing where required. For construction projects, all products which the customer is intending to use on a particular project must be approved in writing by the customer's building designer, system designer or design control professional, to ensure compliance with the latest regulations.

The information contained in Tenmat data sheets is presented in good faith. Tenmat Limited makes passive fire protection product suggestions based solely upon and limited to the information made available to Tenmat. Tenmat possesses knowledge of fire test data and offers manufacturers installation advice. Within reason, Tenmat is skilled at offering opinion concerning the installations in question, and can comment on interfaces with other construction materials, but this is not a recommendation or decision. Decisions on overall building fire strategy are not made by Tenmat. Tenmat products have been tested for a wide range of construction types, and they must be only used in accordance with Tenmat test evidence. Each specific Tenmat product must be installed into a construction that matches the corresponding test report. Tenmat product performance requires safe and proper handling and correct installation.

Doc Reference: TDS-38		
Revision: 3		Date: 03/12/2025
PB: CM	CB: CT	AB: DR